

Perturbation theory for Lagrangian subspaces of symplectic matrices

Christian Mehl
Institut für Mathematik
Technische Universität Berlin

**Third Berlin-Manchester Workshop on
Nonlinear Eigenvalue Problems**

Manchester, March 22-23, 2007

joint work with Volker Mehrmann, André Ran, and Leiba Rodman

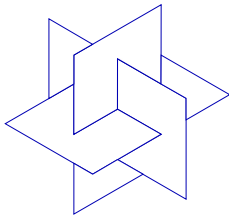

Work supported by DFG Research Center
MATHEON – Mathematics for key technologies

Palindromic polynomial eigenvalue problems

Application: vibration analysis of rail tracks excited by high speed trains

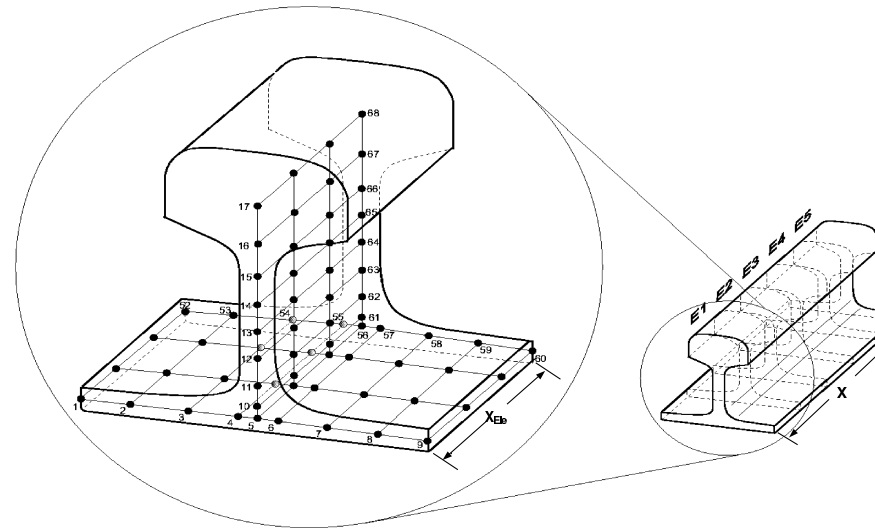

Finite element discretization leads to a **palindromic eigenvalue problem**

$$(\lambda^2 A_0^T + \lambda A_1 + A_0)x = 0,$$

where $A_0, A_1 \in \mathbb{C}^{n \times n}$, $A_1^T = A_0$, and A_0 is highly singular.

Palindromic polynomial eigenvalue problems

More applications:

- simulation of surface acoustic wave (SAW) filters (Zaglmayr 2002)
- computation of the Crawford number (Higham/Tisseur/Van Dooren 2002)

Important task: (sometimes) compute the deflating subspace associated with the eigenvalues inside (resp. outside) the unit circle

Question: What happens if there are eigenvalues close to the unit circle?

We need a perturbation theory for deflating subspaces!

Palindromics and symplectics

Helpful observation: Palindromic matrix polynomials are related to symplectic matrices (Schröder 2005)

Example: $P(\lambda) = \lambda^2 A + B + A^T$ can be linearized as

$$L_Z(\lambda) = \lambda Z + Z^T = \lambda \begin{bmatrix} A & B - A^T \\ A & A \end{bmatrix} + \begin{bmatrix} A^T & A^T \\ B - A & A^T \end{bmatrix}$$

if -1 is not an eigenvalue of $P(\lambda)$.

$Z^{-1}Z^T$ is similar to a symplectic matrix if 1 is not an eigenvalue of $P(\lambda)$.

Symplectic matrices

Symplectic matrices: $S \in \mathbb{F}^{2n \times 2n}$ is called **symplectic** if

$$S^T J S = J, \quad \text{where } J = \begin{bmatrix} 0 & I_n \\ -I_n & 0 \end{bmatrix}.$$

Definition: (more general)

1) Let $J \in \mathbb{F}^{2n \times 2n}$ be a skew-symmetric invertible matrix.

- A matrix $S \in \mathbb{F}^{2n \times 2n}$ is called **J -symplectic** if $S^T J S = J$.

2) Let $J \in \mathbb{C}^{m \times m}$ be a Hermitian invertible matrix.

- A matrix $S \in \mathbb{C}^{m \times m}$ is called **J -unitary** if $S^* J S = J$.

Assumption: In 2), we assume J has n negative and n positive eigenvalues.

Then J is congruent to

$$i \begin{bmatrix} 0 & I_n \\ -I_n & 0 \end{bmatrix}.$$

Canonical forms for symplectic matrices

Three cases:

- Complex J -symplectics ($J^T = -J$, $S^T JS = J$);
- Real J -symplectics ($J^T = -J$, $S^T JS = J$);
- Complex J -unitaries ($J^* = J$, $S^* JS = J$);
(and J has n negative and n positive eigenvalues);

Transformations that preserve structure:

- for J -symplectics: $(J, S) \mapsto (P^T JP, P^{-1}SP)$, P invertible;
- for J -unitaries: $(J, S) \mapsto (P^* JP, P^{-1}SP)$, P invertible;

Canonical forms for symplectic matrices

Case 1: Complex J -symplectics ($J^T = -J$, $S^T JS = J$)

- eigenvalues occur in reciprocal pairs: if λ is an eigenvalue, then so is λ^{-1} with the same algebraic multiplicity;
- the pairing also occurs with respect to the Jordan structure;
- the pairing degenerates for $\lambda = \pm 1$;
- the total number m_q of Jordan blocks of size $2q + 1$ associated with the eigenvalue $\lambda = +1$ is even;
- the total number m_r of Jordan blocks of size $2r + 1$ associated with the eigenvalue $\lambda = -1$ is even;

Canonical forms for symplectic matrices

Case 2: Complex J -unitaries ($J^* = J$, $S^*JS = J$)

- eigenvalues occur in conjugate reciprocal pairs: if λ is an eigenvalue, then so is $\bar{\lambda}^{-1}$ with the same algebraic multiplicity;
- the pairing also occurs with respect to the Jordan structure;
- the pairing degenerates for unimodular eigenvalues λ (i.e., $|\lambda| = 1$);
- unimodular eigenvalues have **signs** as additional invariants, e.g.,

$$J = \begin{bmatrix} 0 & 1 \\ -1 & 0 \end{bmatrix}, \quad S_1 = \begin{bmatrix} 1 & 1 \\ 0 & 1 \end{bmatrix}, \quad S_2 = \begin{bmatrix} 1 & -1 \\ 0 & 1 \end{bmatrix};$$

S_1 and S_2 are similar, but the pairs (J, S_1) and (J, S_2) are not equivalent;

- the collection of signs is called the **sign characteristic** of (J, S) ;

Canonical forms for symplectic matrices

Case 3: Real J -symplectics ($J^T = -J$, $S^T JS = J$)

- eigenvalues occur in quadruplets: if λ is an eigenvalue, then so are $\bar{\lambda}$, λ^{-1} , and $\bar{\lambda}^{-1}$ with the same algebraic multiplicity;
- the pairing also occurs with respect to the Jordan structure;
- the pairing degenerates for unimodular eigenvalues λ (i.e., $|\lambda| = 1$);
- unimodular eigenvalues have **signs** as additional invariants;
- the sign characteristics associated with λ and $\bar{\lambda}$ are related;
- the total numbers $m_{q,\pm}$ of Jordan blocks of size $2q + 1$ associated with the eigenvalues $\lambda = \pm 1$ are even;

Lagrangian subspaces

Definition:

1) Let $J \in \mathbb{F}^{2n \times 2n}$ be a skew-symmetric invertible matrix.

- A subspace $\mathcal{M} \subseteq \mathbb{F}^{2n}$ is called **J -Lagrangian** if $\dim \mathcal{M} = n$ and

$$y^T J x = 0 \quad \text{for all } x, y \in \mathcal{M}.$$

2) Let $J \in \mathbb{C}^{2n \times 2n}$ be a Hermitian matrix with n positive and n negative eigenvalues.

- A subspace $\mathcal{M} \subseteq \mathbb{C}^{2n}$ is called **J -Lagrangian** if $\dim \mathcal{M} = n$ and

$$y^* J x = 0 \quad \text{for all } x, y \in \mathcal{M}.$$

J -Lagrangian subspaces are maximal J -neutral subspaces.

Lagrangian subspaces

Aim: Study J -Lagrangian subspaces that are invariant for a J -symplectic S .

Examples:

$$1) J = \begin{bmatrix} 0 & 1 \\ -1 & 0 \end{bmatrix}, S = \begin{bmatrix} 1 & 1 \\ 0 & 1 \end{bmatrix}, \mathcal{M} = \text{span} \left(\begin{bmatrix} 1 \\ 0 \end{bmatrix} \right);$$

\mathcal{M} is an S -invariant J -Lagrangian subspace;

$$2) J = \begin{bmatrix} 0 & I_n \\ -I_n & 0 \end{bmatrix}, S = \begin{bmatrix} S_1 & 0 \\ 0 & (S_1^{-1})^T \end{bmatrix}, \mathcal{M} = \text{span} \left(\begin{bmatrix} I_n \\ 0 \end{bmatrix} \right);$$

\mathcal{M} is an S -invariant J -Lagrangian subspace;

Special case: If S has no unimodular eigenvalues, then the invariant subspace associated with the eigenvalues inside the unit circle is J -Lagrangian.

Stability of Lagrangian subspaces

$\mathcal{L}(J, S) := \{\mathcal{M} \subseteq \mathbb{F}^{2n} : \mathcal{M} \text{ is } S\text{-invariant and } J\text{-Lagrangian}\}$

Definition: Let S, S' be J -symplectic and let \mathcal{M} be an S -invariant J -Lagrangian subspace.

1) \mathcal{M} is called **stable** if for every $\varepsilon > 0$ there exists $\delta > 0$ such that

$$\|S - S'\| < \delta \Rightarrow \exists \mathcal{M}' \in \mathcal{L}(J, S') : \text{gap}(\mathcal{M}, \mathcal{M}') < \varepsilon.$$

2) \mathcal{M} is called **conditionally stable** if for every $\varepsilon > 0$ there exists $\delta > 0$ such that

$$\|S - S'\| < \delta \text{ and } \mathcal{L}(J, S') \neq \emptyset \Rightarrow \exists \mathcal{M}' \in \mathcal{L}(J, S') : \text{gap}(\mathcal{M}, \mathcal{M}') < \varepsilon.$$

Gap metric: $\text{gap}(\mathcal{M}, \mathcal{N}) := \|P_{\mathcal{M}} - P_{\mathcal{N}}\|;$
($P_{\mathcal{M}}, P_{\mathcal{N}}$: orthogonal projections onto \mathcal{M}, \mathcal{N});

Stability of Lagrangian subspaces

Case 1: Complex J -symplectics ($J^T = -J$, $S^T JS = J$)

Theorem: Every J -symplectic matrix S has an invariant J -Lagrangian subspace associated with eigenvalues in the closed unit disc.

Theorem: The following assertions are equivalent for an S -invariant J -Lagrangian subspace \mathcal{M} :

- \mathcal{M} is stable;
- \mathcal{M} is conditionally stable;
- $\dim \text{Ker}(S + 1) \leq 1$ and $\dim \text{Ker}(S - 1) \leq 1$

What happens under perturbations?

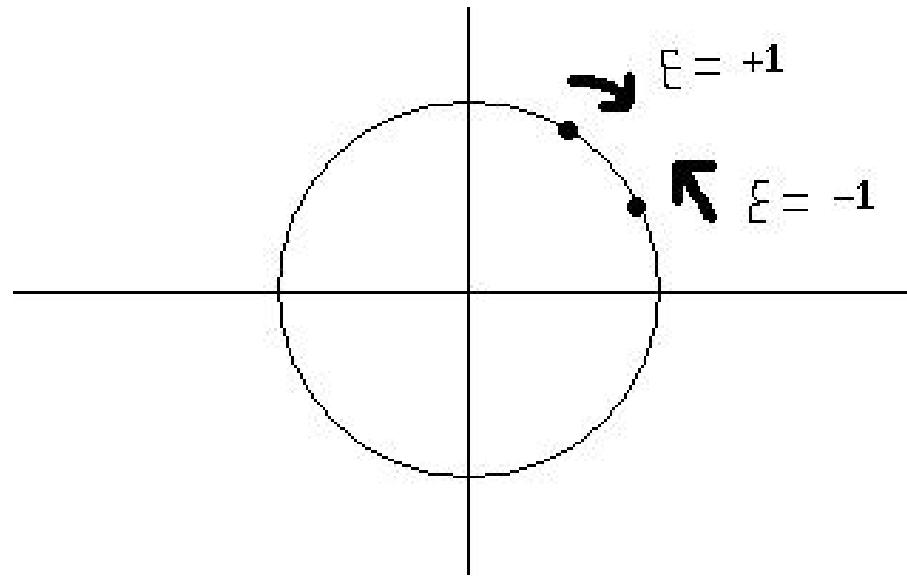

- let $S \in \mathbb{R}^{2n \times 2n}$ be J -symplectic, resp., let $S \in \mathbb{C}^{2n \times 2n}$ be J -unitary;
- let S have two close unimodular eigenvalues with opposite signs;
- if S is perturbed and the two eigenvalues meet, they generically form a Jordan block; then they may split off as a pair of nonunimodular reciprocal eigenvalues;

What happens under perturbations?

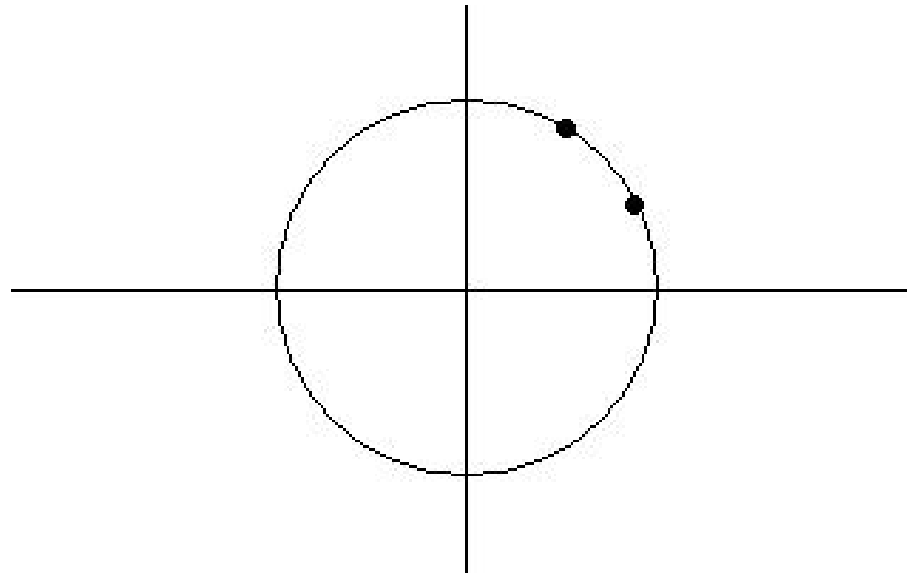

- let $S \in \mathbb{R}^{2n \times 2n}$ be J -symplectic, resp., let $S \in \mathbb{C}^{2n \times 2n}$ be J -unitary;
- let S have two close unimodular eigenvalues with opposite signs;
- if S is perturbed and the two eigenvalues meet, they generically form a Jordan block; then they may split off as a pair of nonunimodular reciprocal eigenvalues;

What happens under perturbations?

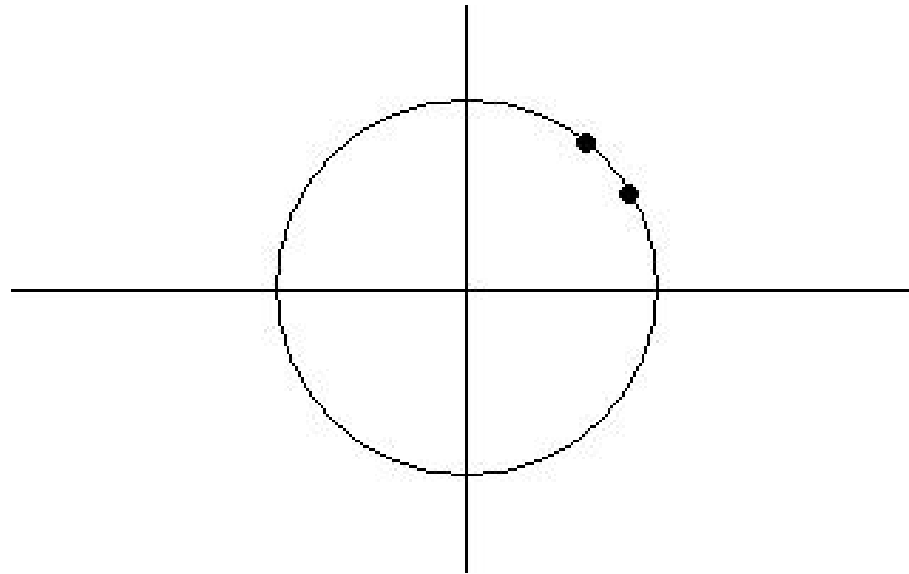

- let $S \in \mathbb{R}^{2n \times 2n}$ be J -symplectic, resp., let $S \in \mathbb{C}^{2n \times 2n}$ be J -unitary;
- let S have two close unimodular eigenvalues with opposite signs;
- if S is perturbed and the two eigenvalues meet, they generically form a Jordan block; then they may split off as a pair of nonunimodular reciprocal eigenvalues;

What happens under perturbations?

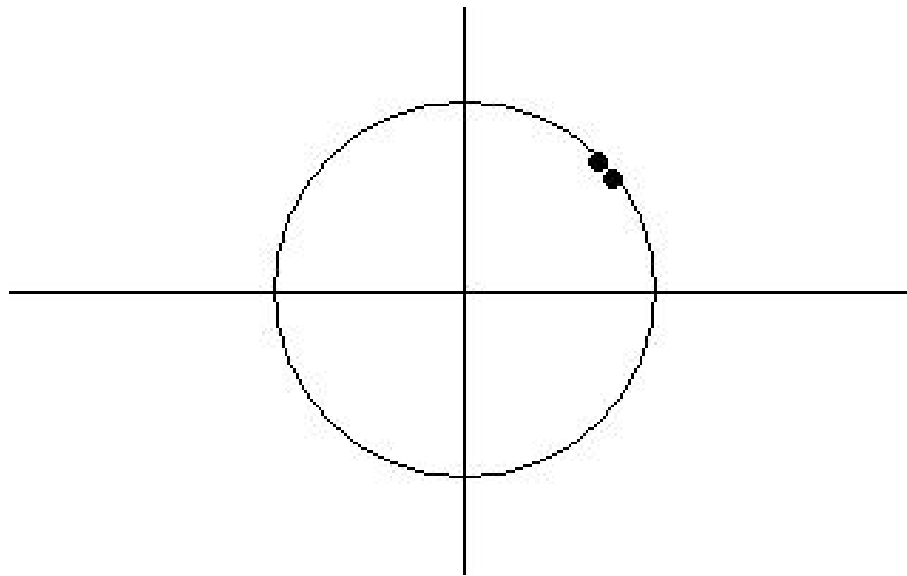

- let $S \in \mathbb{R}^{2n \times 2n}$ be J -symplectic, resp., let $S \in \mathbb{C}^{2n \times 2n}$ be J -unitary;
- let S have two close unimodular eigenvalues with opposite signs;
- if S is perturbed and the two eigenvalues meet, they generically form a Jordan block; then they may split off as a pair of nonunimodular reciprocal eigenvalues;

What happens under perturbations?

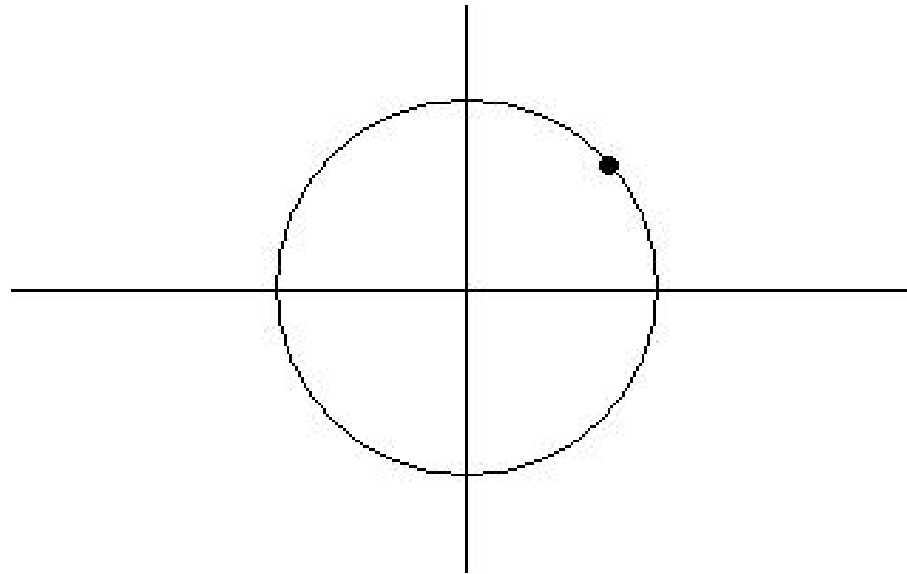

- let $S \in \mathbb{R}^{2n \times 2n}$ be J -symplectic, resp., let $S \in \mathbb{C}^{2n \times 2n}$ be J -unitary;
- let S have two close unimodular eigenvalues with opposite signs;
- if S is perturbed and the two eigenvalues meet, they generically form a Jordan block; then they may split off as a pair of nonunimodular reciprocal eigenvalues;

What happens under perturbations?

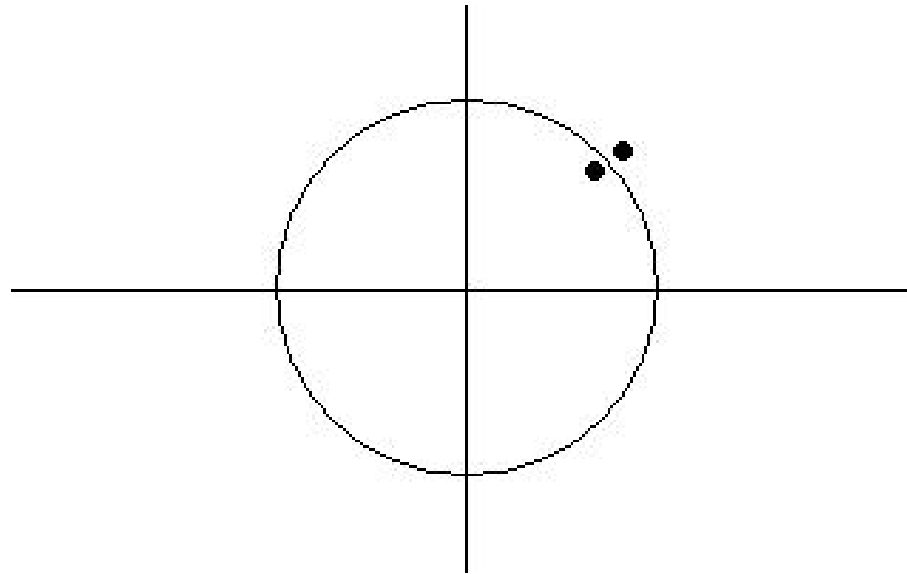

- let $S \in \mathbb{R}^{2n \times 2n}$ be J -symplectic, resp., let $S \in \mathbb{C}^{2n \times 2n}$ be J -unitary;
- let S have two close unimodular eigenvalues with opposite signs;
- if S is perturbed and the two eigenvalues meet, they generically form a Jordan block; then they may split off as a pair of nonunimodular reciprocal eigenvalues;

What happens under perturbations?

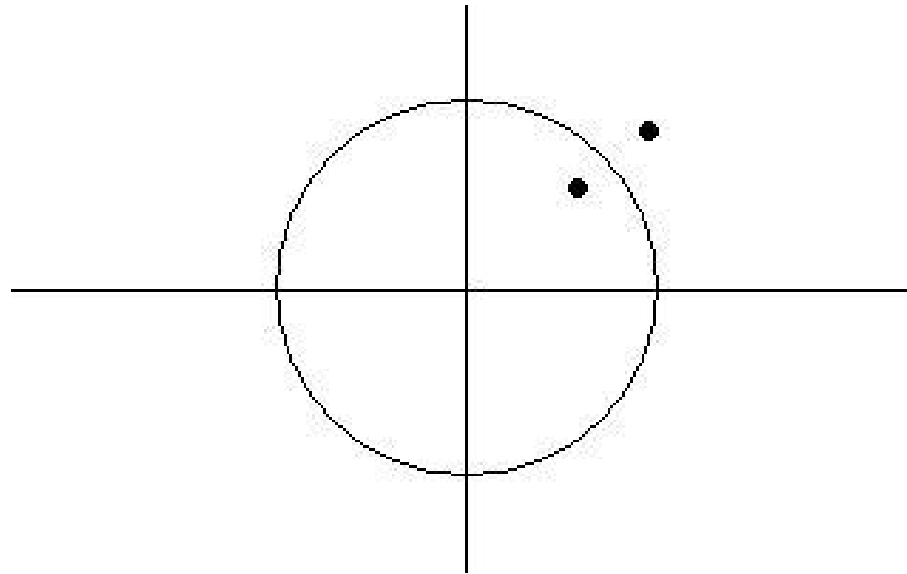

- let $S \in \mathbb{R}^{2n \times 2n}$ be J -symplectic, resp., let $S \in \mathbb{C}^{2n \times 2n}$ be J -unitary;
- let S have two close unimodular eigenvalues with opposite signs;
- if S is perturbed and the two eigenvalues meet, they generically form a Jordan block; then they may split off as a pair of nonunimodular reciprocal eigenvalues;

What happens under perturbations?

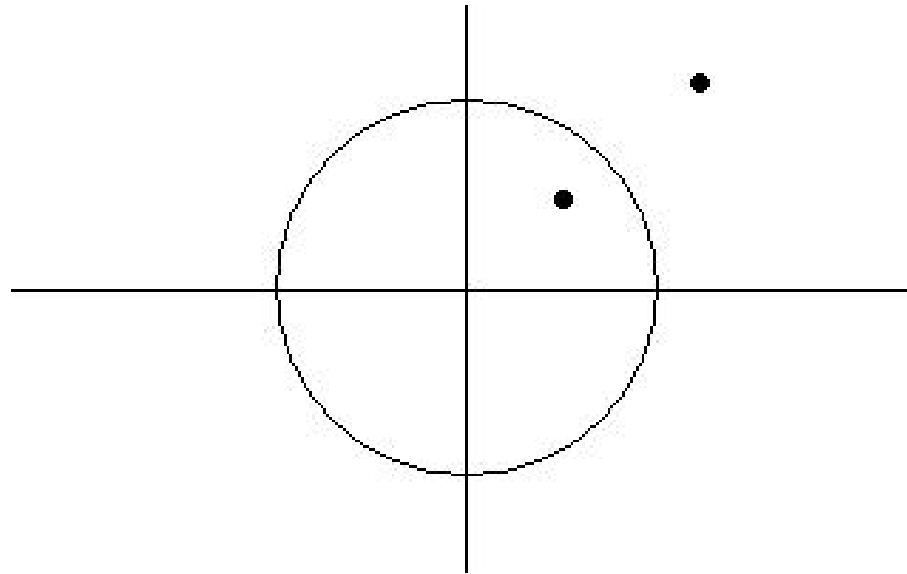

- let $S \in \mathbb{R}^{2n \times 2n}$ be J -symplectic, resp., let $S \in \mathbb{C}^{2n \times 2n}$ be J -unitary;
- let S have two close unimodular eigenvalues with opposite signs;
- if S is perturbed and the two eigenvalues meet, they generically form a Jordan block; then they may split off as a pair of nonunimodular reciprocal eigenvalues;

What happens under perturbations?

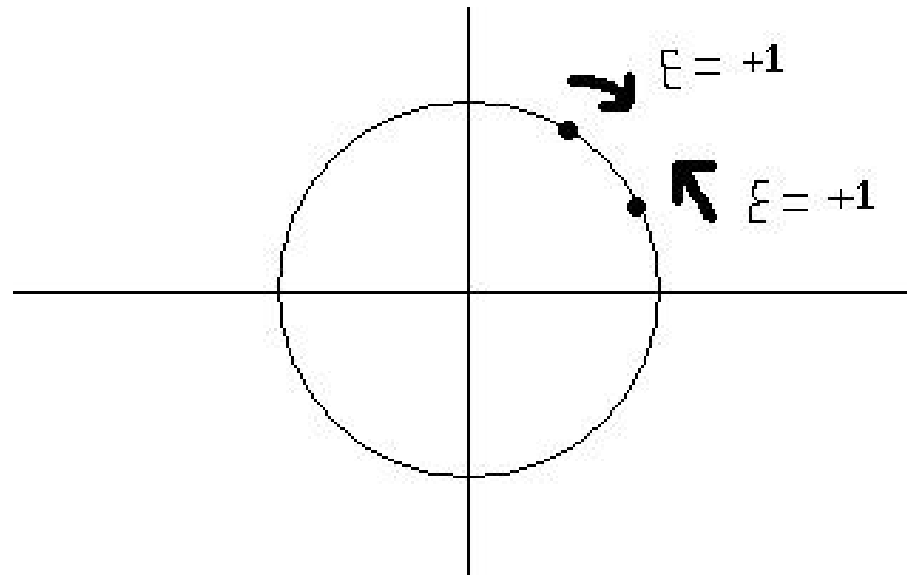

- let $S \in \mathbb{R}^{2n \times 2n}$ be J -symplectic, resp., let $S \in \mathbb{C}^{2n \times 2n}$ be J -unitary;
- let S have two close unimodular eigenvalues with equal signs;
- if S is perturbed and the two eigenvalues meet, they *cannot* form a Jordan block, and they *must* remain on the unit circle;

What happens under perturbations?

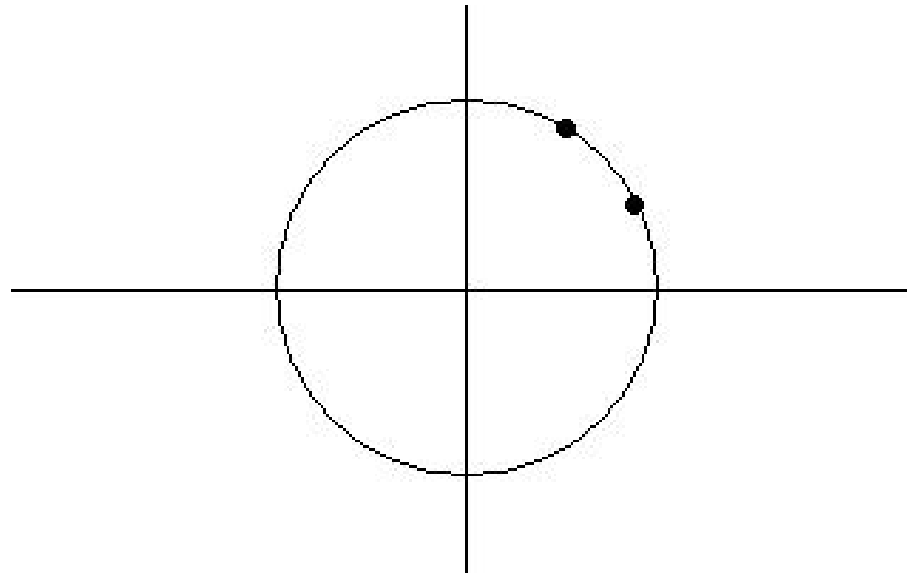

- let $S \in \mathbb{R}^{2n \times 2n}$ be J -symplectic, resp., let $S \in \mathbb{C}^{2n \times 2n}$ be J -unitary;
- let S have two close unimodular eigenvalues with equal signs;
- if S is perturbed and the two eigenvalues meet, they *cannot* form a Jordan block, and they *must* remain on the unit circle;

What happens under perturbations?

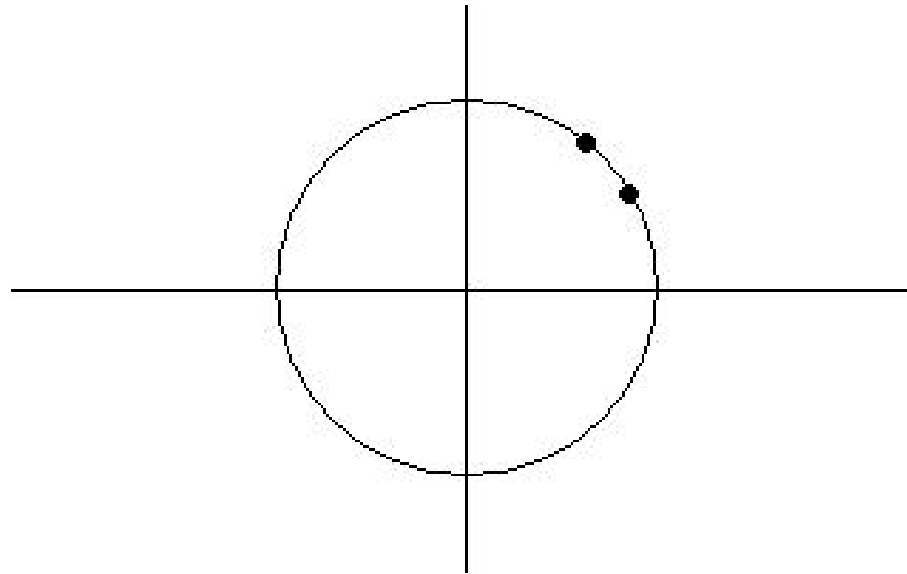

- let $S \in \mathbb{R}^{2n \times 2n}$ be J -symplectic, resp., let $S \in \mathbb{C}^{2n \times 2n}$ be J -unitary;
- let S have two close unimodular eigenvalues with equal signs;
- if S is perturbed and the two eigenvalues meet, they *cannot* form a Jordan block, and they *must* remain on the unit circle;

What happens under perturbations?

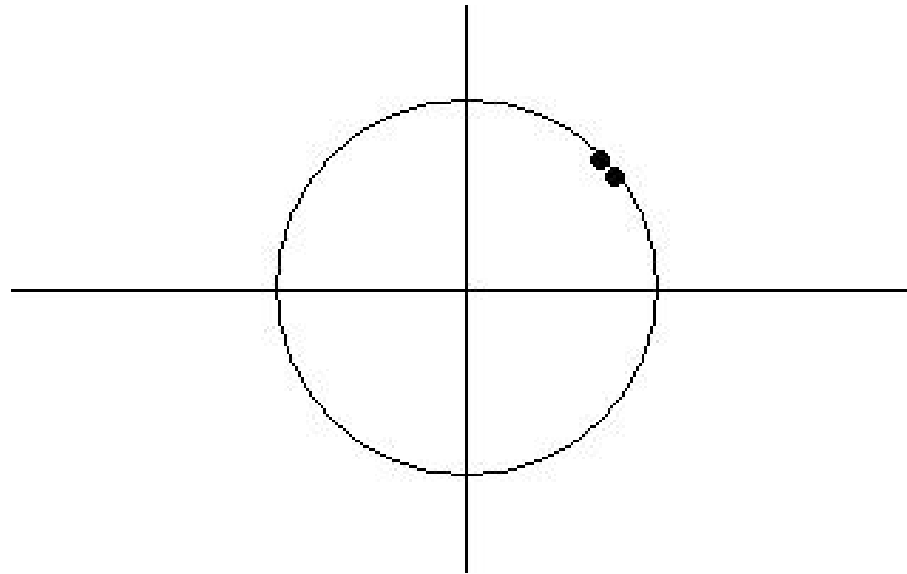

- let $S \in \mathbb{R}^{2n \times 2n}$ be J -symplectic, resp., let $S \in \mathbb{C}^{2n \times 2n}$ be J -unitary;
- let S have two close unimodular eigenvalues with equal signs;
- if S is perturbed and the two eigenvalues meet, they *cannot* form a Jordan block, and they *must* remain on the unit circle;

What happens under perturbations?

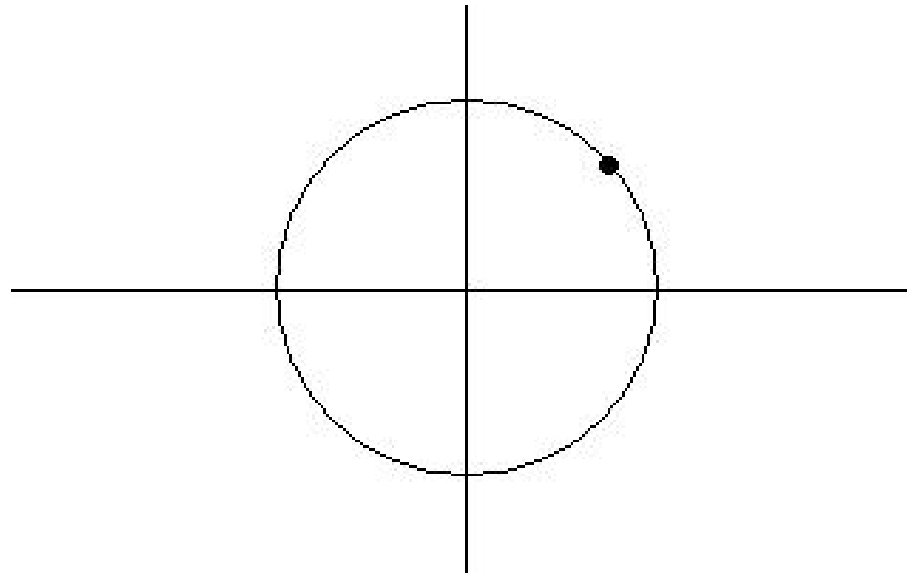

- let $S \in \mathbb{R}^{2n \times 2n}$ be J -symplectic, resp., let $S \in \mathbb{C}^{2n \times 2n}$ be J -unitary;
- let S have two close unimodular eigenvalues with equal signs;
- if S is perturbed and the two eigenvalues meet, they *cannot* form a Jordan block, and they *must* remain on the unit circle;

What happens under perturbations?

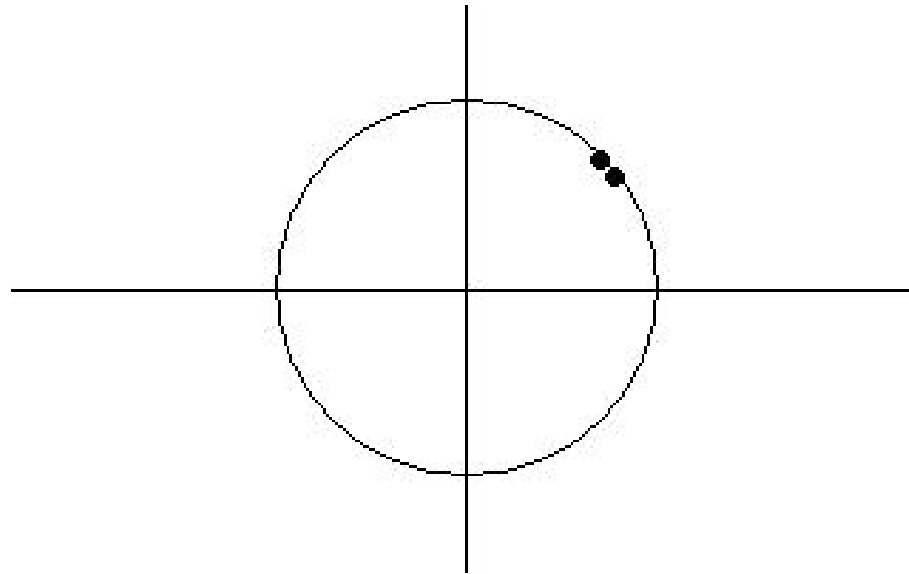

- let $S \in \mathbb{R}^{2n \times 2n}$ be J -symplectic, resp., let $S \in \mathbb{C}^{2n \times 2n}$ be J -unitary;
- let S have two close unimodular eigenvalues with equal signs;
- if S is perturbed and the two eigenvalues meet, they *cannot* form a Jordan block, and they *must* remain on the unit circle;

What happens under perturbations?

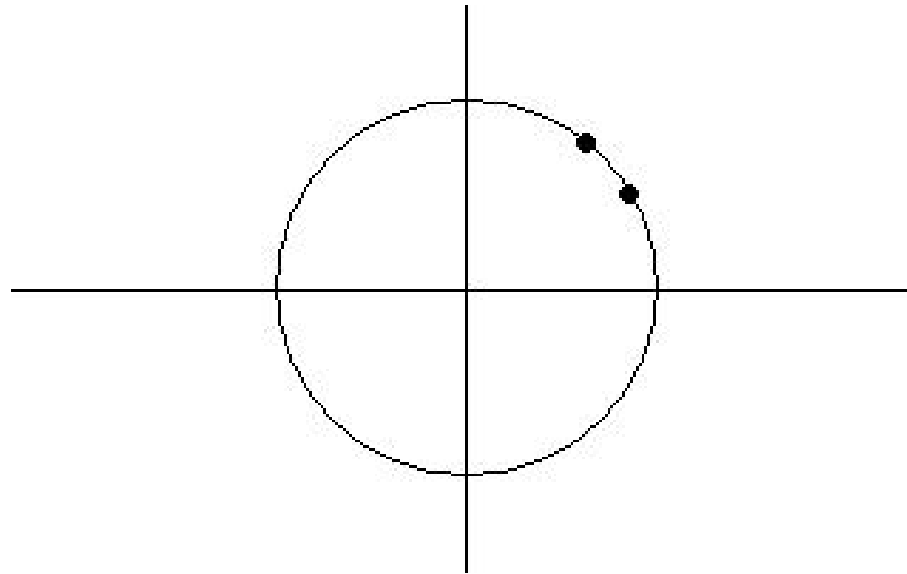

- let $S \in \mathbb{R}^{2n \times 2n}$ be J -symplectic, resp., let $S \in \mathbb{C}^{2n \times 2n}$ be J -unitary;
- let S have two close unimodular eigenvalues with equal signs;
- if S is perturbed and the two eigenvalues meet, they *cannot* form a Jordan block, and they *must* remain on the unit circle;

What happens under perturbations?

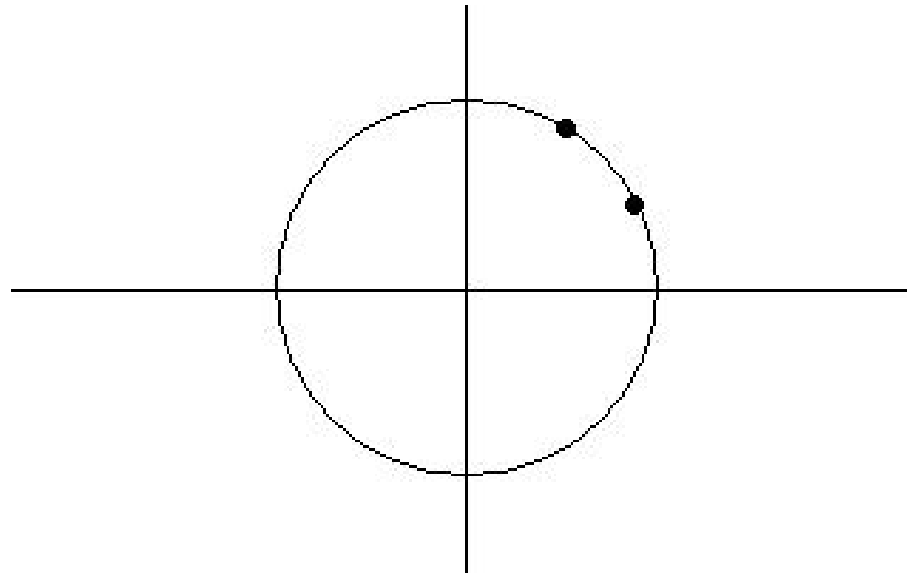

- let $S \in \mathbb{R}^{2n \times 2n}$ be J -symplectic, resp., let $S \in \mathbb{C}^{2n \times 2n}$ be J -unitary;
- let S have two close unimodular eigenvalues with equal signs;
- if S is perturbed and the two eigenvalues meet, they *cannot* form a Jordan block, and they *must* remain on the unit circle;

Stability of Lagrangian subspaces

Case 2: Complex J -unitaries ($J^* = J$, $S^*JS = J$)

Theorem: Let S be J -unitary. There exists an S -invariant J -Lagrangian subspace if and only if for every unimodular eigenvalue $\omega \in \mathbb{C}$, $|\omega| = 1$, the number of odd partial multiplicities corresponding to ω is even, and the signs in the sign characteristic of S that correspond to these odd partial multiplicities sum up to zero.

Theorem: Let S be J -unitary. There exists a stable S -invariant J -Lagrangian subspace if and only if S has no unimodular eigenvalues.

Stability of Lagrangian subspaces

Case 2: Complex J -unitaries ($J^* = J$, $S^*JS = J$)

Theorem: Let S be J -unitary. There exists a conditionally stable S -invariant J -Lagrangian subspace if and only if every unimodular eigenvalue ω has only even partial multiplicities, and all the signs in the sign characteristic of S corresponding to ω are equal.

Stability of Lagrangian subspaces

Case 3: Real J -symplectics ($J^T = -J$, $S^T JS = J$)

Theorem: Let S be J -symplectic. There exists an S -invariant J -Lagrangian subspace if and only if for every unimodular eigenvalue $\omega \in \mathbb{C} \setminus \mathbb{R}$, $|\omega| = 1$, the number of odd partial multiplicities corresponding to ω is even, and the signs in the sign characteristic of S that correspond to these odd partial multiplicities sum up to zero.

Theorem: Let S be J -symplectic. There exists a stable S -invariant J -Lagrangian subspace if and only if S has no unimodular eigenvalues.

Stability of Lagrangian subspaces

Case 3: Real J -symplectics ($J^T = -J$, $S^T J S = J$)

Theorem: Let S be J -symplectic. There exists a conditionally stable S -invariant J -Lagrangian subspace if and only if:

- 1) every unimodular eigenvalue $\omega \neq \pm 1$ has only even partial multiplicities, and all the signs in the sign characteristic corresponding to ω are equal.
- 2) the eigenvalue 1 of S only has even partial multiplicities, say $2n_1, \dots, 2n_p$, and if $\kappa_1, \dots, \kappa_p$ are the corresponding signs, then

$$(-1)^{n_1} \kappa_1 = (-1)^{n_2} \kappa_2 = \dots = (-1)^{n_p} \kappa_p.$$

- 3) the eigenvalue -1 of S only has even partial multiplicities, say $2n'_1, \dots, 2n'_{p'}$, and if $\kappa'_1, \dots, \kappa'_{p'}$ are the corresponding signs, then

$$(-1)^{n'_1} \kappa'_1 = (-1)^{n'_2} \kappa'_2 = \dots = (-1)^{n'_{p'}} \kappa'_{p'}.$$

Index of stability of Lagrangian subspaces

Definition: Let S, S' be J -symplectic and let \mathcal{M} be an S -invariant J -Lagrangian subspace.

1) \mathcal{M} is called **α -stable** if there exists $\delta, K > 0$ such that

$$\|S - S'\| < \delta \Rightarrow \exists \mathcal{M}' \in \mathcal{L}(J, S') : \text{gap}(\mathcal{M}, \mathcal{M}') \leq K \|S - S'\|^{1/\alpha}.$$

2) $\alpha_0 \geq 1$ is the **index of stability** of \mathcal{M} if \mathcal{M} is α_0 -stable, but not α -stable for any $\alpha < \alpha_0$.

3) ... (analogously: **conditional α -stability** and **index of conditional α -stability**) ...

Open problem: For an α -stable S -invariant J -Lagrangian subspace determine the index of (conditional) α -stability if it exists. (So far: bounds and answers for special cases.)

Conclusions

- perturbation theory for J -Lagrangian invariant subspaces of J -symplectic matrices now complete;
- open problem: extend the results to palindromic matrix pencils and palindromic matrix polynomials;
- Reference: M., Mehrmann, Ran, Rodman. *Perturbation analysis of Lagrangian invariant subspaces of symplectic matrices*. MATHEON preprint, TU Berlin, 2006, available from <http://www.matheon.de>.